

TVE

Torrino di estrazione assiale a getto verticale



Prodotto

TVE

Costruzione

Base con anello cilindrico in acciaio zincato, girante elicoidale con pale a profilo alare in polipropilene rinforzato con fibra di vetro e mozzo in pressofusione di alluminio, anello paravento in acciaio zincato, serranda a gravità antipioggia in alluminio, rete di protezione tra girante e serranda

Applicazioni

Estrazione vapori e fumi, rinnovo aria in edifici commerciali e officine, magazzini

CARATTERISTICHE

Estrattore assiale da tetto a getto verticale, per estrazione aria viziata con temperatura di esercizio compresa tra i -20°C e i +50 °C. Trova impiego sia in capannoni industriali, magazzini ecc. ma anche in edifici commerciali e in generale in tutti quei casi dove si rende necessaria l'aspirazione di grandi portate d'aria (comprese tra i 1000 m³/h e i 110000 m³/h). La serie standard offre diverse taglie ventilatore con diametri della girante compresi tra 500 mm e 1400 mm.

VENTILATORE

Girante elicoidale con pale a profilo alare in polipropilene rinforzato con fibra di vetro, mozzo in pressofusione di alluminio.

MOTORE

Grado di protezione IP 55 e isolamento classe "F", motori monofase aventi tensione alimentazione 230 V 50 Hz, motori trifase a una velocità con tensione 230/400 V 50 Hz, motori trifase a due velocità con unica tensione 400 V 50 Hz.

DIMENSIONALI

TVE

Taglia	Dimensioni (mm)								Peso kg
	ØA	ØB	C	D	E	F	G	h	
500	680	516	650	750	40	450	450	800	63
560	730	564	750	850	45	450	480	830	74
630	800	640	800	900	45	450	520	870	92
710	875	715	900	1000	45	450	560	910	103
800	950	810	1000	1100	45	620	600	1120	120
900	1070	910	1150	1250	45	620	600	1170	155
1000	1170	1010	1300	1400	45	700	600	1300	177
1125	1290	1125	1450	1550	50	700	760	1350	210
1250	1410	1250	1600	1700	50	900	820	1650	245
1400	1560	1400	1750	1850	50	1000	900	1800	290





TABELLA DI SELEZIONE RAPIDA

Modello TRV/TRV	Dati tecnici				
	Fase	Portata aria max (m ³ /h)	Pressione st. max (Pa)	Potenza (kW)	Velocità (RPM)
TVE 504 M	1	9200	145	0,55	1400
TVE 504 T	3	9200	145	0,55	1400
TVE 506 T	3	6000	65	0,18	900
TVE 504/6 T	3	9200/6000	145/65	0,55/0,18	1400/900
TVE 564 M	1	13300	225	1,1	1400
TVE 564 T	3	13300	225	1,1	1400
TVE 566 T	3	8150	85	0,37	900
TVE 56/8 T	3	6450	80	0,12	700
TVE 564/6 T	3	13300/8150	225/85	1,1/0,37	1400/900
TVE 566/8 T	3	8150/6450	85/80	0,37/0,12	900/700
TVE 634 M	3	17100	240	1,5	1400
TVE 636 T	3	10600	95	0,37	900
TVE 638 T	3	8000	55	0,18	700
TVE 634/6 T	3	15800/9820	240/95	1,7/0,6	1400/900
TVE 636/8 T	3	10600/8000	95/55	0,37/0,15	900/700
TVE 714 T	3	25700	250	3	1400
TVE 716 T	3	16700	105	0,75	900
TVE 718 T	3	12400	55	0,37	700
TVE 714/6 T	3	25700/16700	250/105	3,0/0,9	1400/900
TVE 716/8 T	3	16700/12400	105/55	1,25/0,60	900/700
TVE 806 T	3	25400	130	1,5	900
TVE 808 T	3	18800	65	0,55	700
TVE 806/8 T	3	25400/18800	130/65	1,25/0,60	900/700
TVE 906 T	3	33800	145	2,2	900
TVE 908 T	3	25000	80	1,1	700
TVE 906/8 T	3	33800/25000	145/80	2,2/1,1	900/700
TVE 1006 T	3	43700	180	3	900
TVE 1008 T	3	33000	100	1,5	700
TVE 1006/8 T	3	43700/33000	180/100	3,5/1,5	900/700
TVE 1126 T	3	71000	280	11	900
TVE 1128 T	3	52300	150	4	700
TVE 1126/8 T	3	71000/52300	280/150	10,0/5,0	900/700
TVE 1256 T	3	91000	300	15	900
TVE 1258 T	3	67400	160	5,5	700
TVE 1256/8 T	3	91000/67400	300/160	16,5/7,8	900/700
TVE 1406 T	3	120000	340	18,5	900
TVE 1408 T	3	89000	185	7,5	700
TVE 1406/8 T	3	120000/89000	340/185	16,5/7,8	900/700

CURVE CARATTERISTICHE 4 POLI

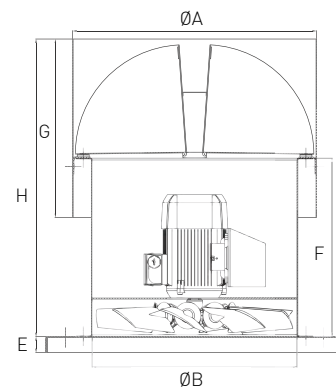
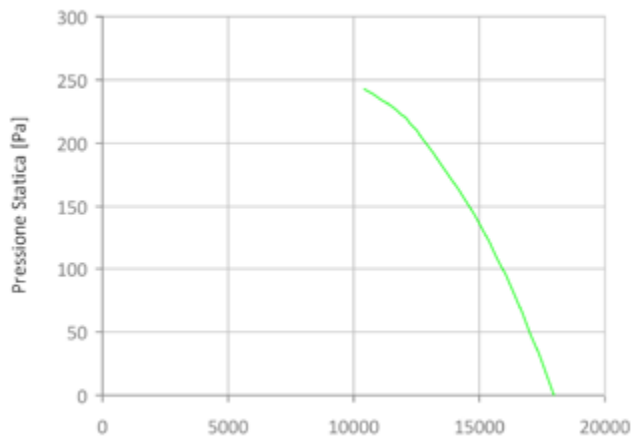
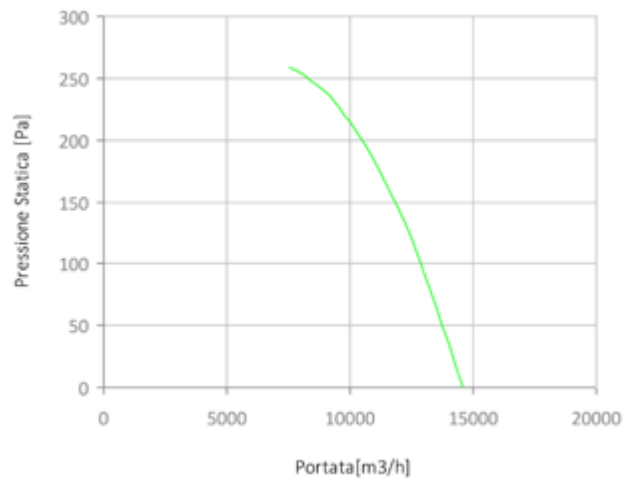
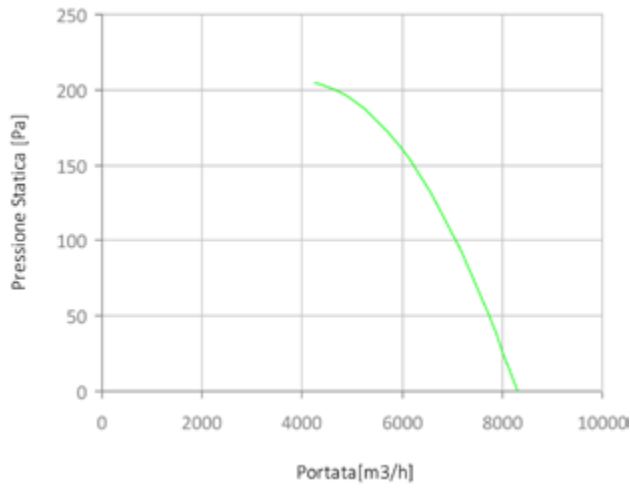



CURVE CARATTERISTICHE 6 POLI

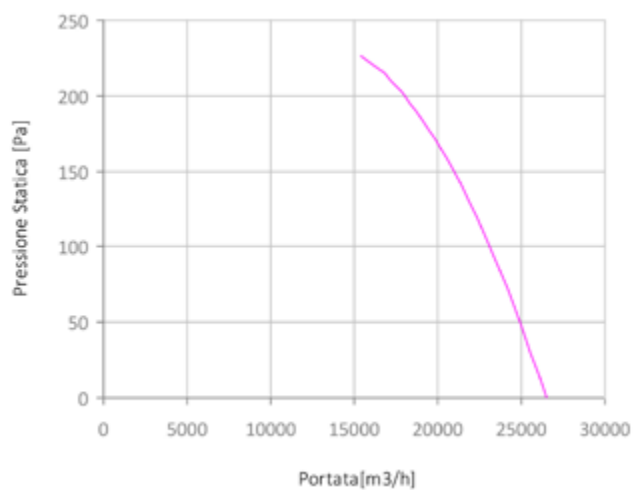
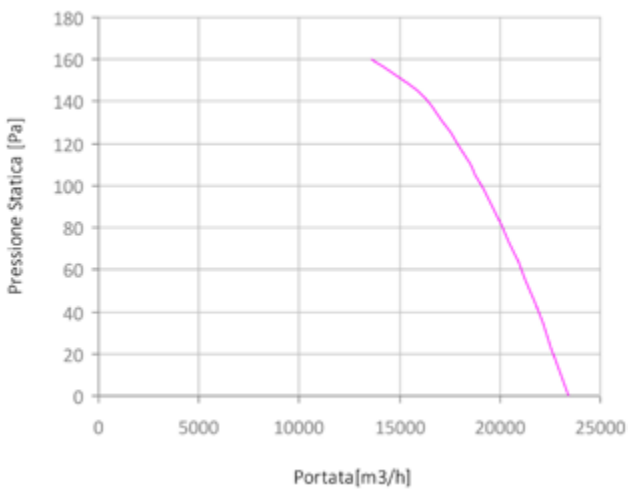
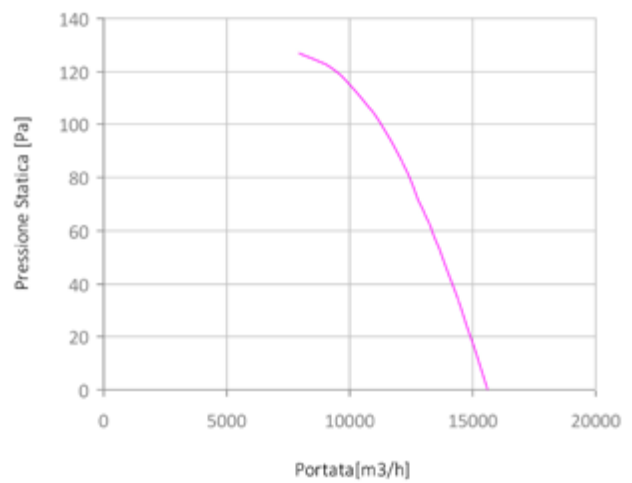
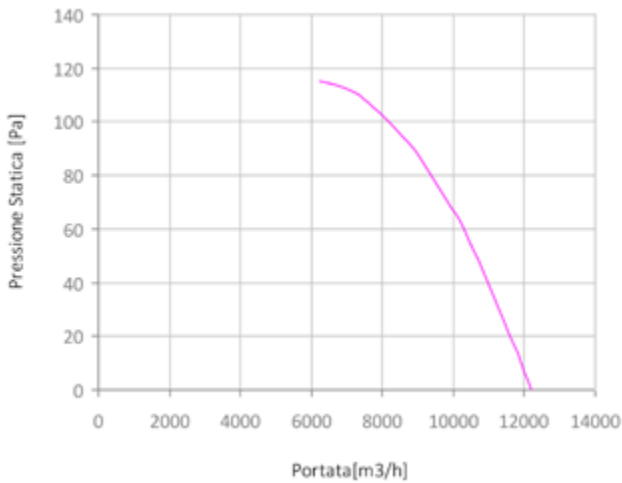
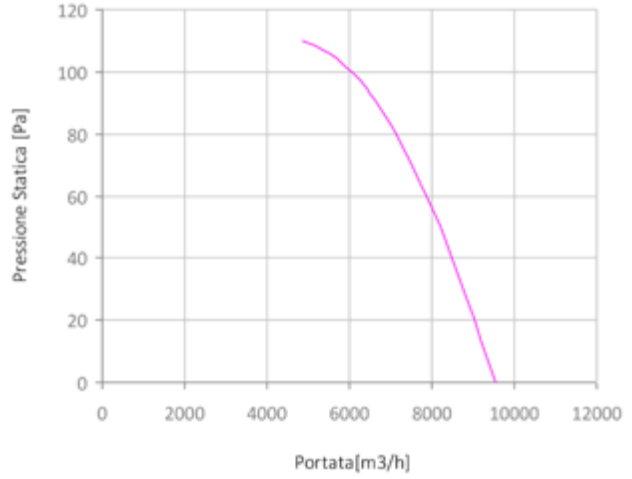
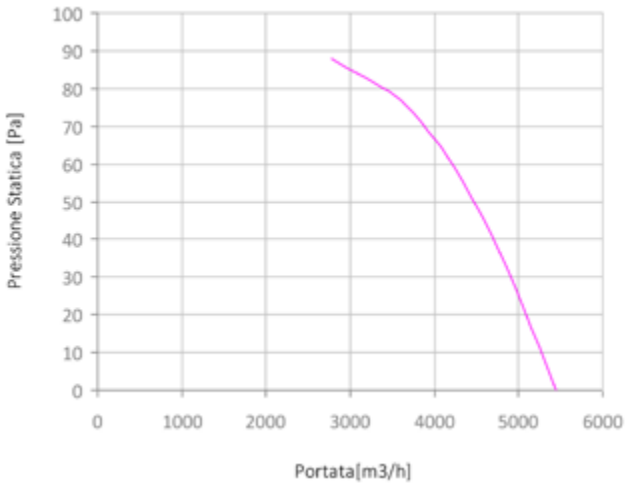

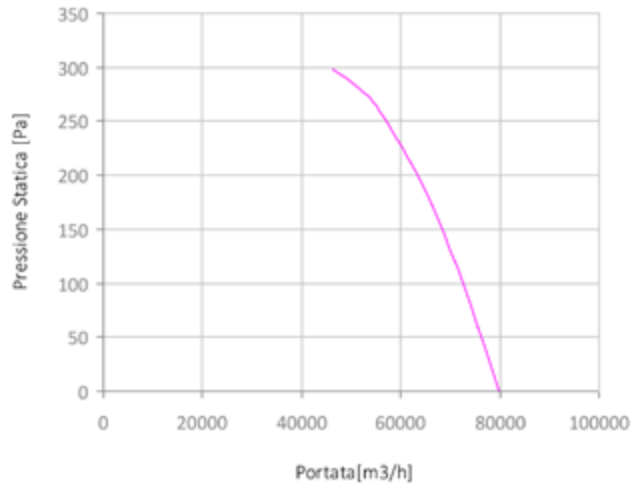
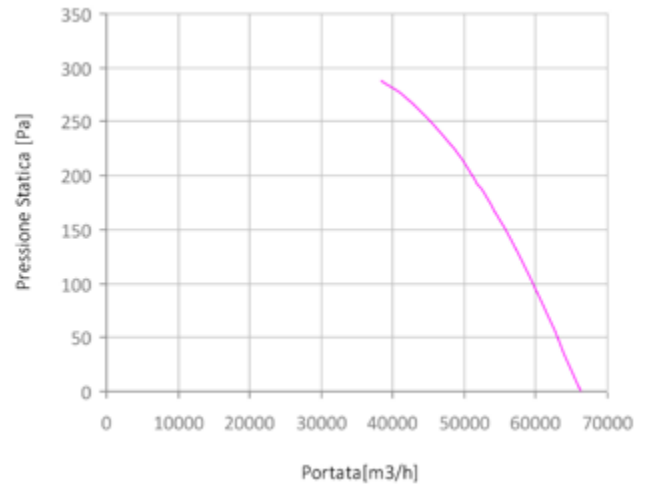
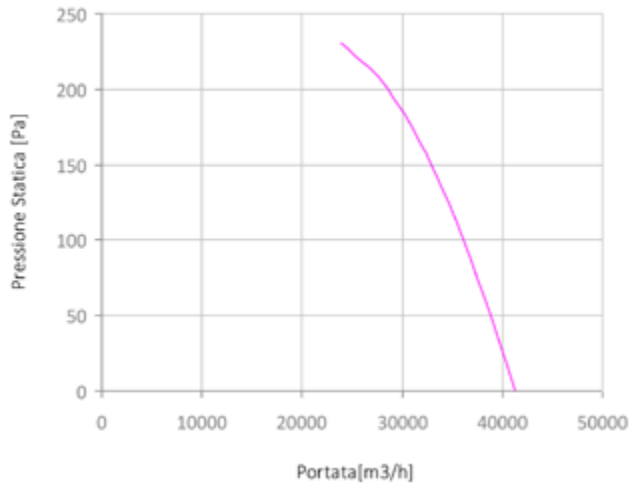



CURVE CARATTERISTICHE 8 POLI

