

TRV

Estrattore centrifugo da tetto a getto verticale



Prodotto

TRV

Costruzione

Base, montanti, piastra porta motore e rete di protezione in lamiera zincata
cappello di protezione in polimero termoplastico (ABS) resistente ai raggi UV

Applicazioni

Estrazione aria viziata con temperatura compresa tra -20 °C e 80 °C in edifici civili e industriali

CARATTERISTICHE

Estrattore centrifugo da tetto a getto verticale, per estrazioni vapori e fumi da cappe da cucina professionali, rinnovo aria in edifici commerciali, officine e magazzini.

VENTILATORE

Girante centrifuga a pale rovesce in lamiera zincata (in alluminio per le taglie 110 e 120).

MOTORE

Grado di protezione IP 55 e isolamento classe "F", motori monofase con tensione alimentazione 230 V 50 Hz, motori trifase a una velocità con tensione 230/400 V 50 Hz, motori trifase a due velocità con unica tensione 400 V 50 Hz.

DIMENSIONALI TRV

Taglia	AxA (mm)	BxB (mm)	C (mm)	DxD (mm)	øE (mm)
05	400	590	40	350	200
20	400	590	40	350	250
30	560	780	40	460	300
40	560	780	40	460	350
50	710	930	40	610	400
60	710	930	40	610	450
70	900	1210	40	800	500
80	900	1210	45	800	550
90	900	1210	45	800	600
100 ¹	900	1210	45	800	600
110 ^{1,2}	1200	1600	50	1100	640
120 ^{1,2}	1200	1600	50	1100	710

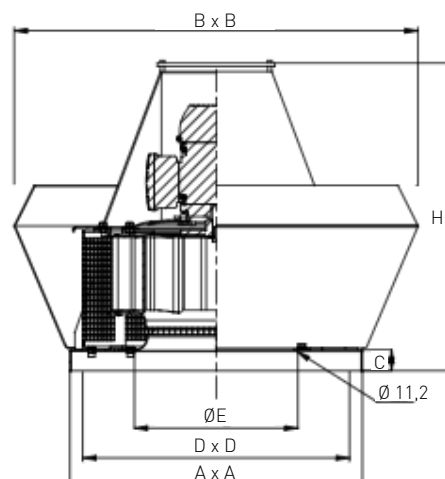

TRC/TRV

Estrattori centrifughi da tetto a getto orizzontale o verticale

TABELLA DI SELEZIONE RAPIDA

Modello TRV/TRV	Dati tecnici				
	Fase	Portata aria max (m ³ /h)	Pressione st. max (Pa)	Potenza (kW)	Velocità (RPM)
TRC/TRV 05 P4M	1	1150	190	0,12	1400
TRC/TRV 05 P4T	3	1150	190	0,12	1400
TRC/TRV 05 P6T	3	750	100	0,09	900
TRC/TRV 20 P4M	1	1800	290	0,18	1400
TRC/TRV 20 P4T	3	1800	290	0,18	1400
TRC/TRV 20 P6T	3	1100	120	0,09	900
TRC/TRV 20 P4/6T	3	1800/1100	120/290	0,26/0,09	1400/900
TRC/TRV 30 P4M	1	3050	380	0,25	1400
TRC/TRV 30 P4T	3	3050	380	0,25	1400
TRC/TRV 30 P6T	3	2000	155	0,18	900
TRC/TRV 30 P8T	3	1600	90	0,12	700
TRC/TRV 30 P4/6T	3	3050/2000	380/155	0,26/0,09	1400/900
TRC/TRV 40 P4M	1	4050	450	0,37	1400
TRC/TRV 40 P4T	3	4050	450	0,37	1400
TRC/TRV 40 P6T	3	2650	185	0,18	900
TRC/TRV 40 P8T	3	1900	130	0,12	700
TRC/TRV 40 P4/6T	3	4050/2650	450/185	0,55/0,18	1400/900
TRC/TRV 50 P4M	1	5600	540	0,75	1400
TRC/TRV 50 P4T	3	5600	540	0,75	1400
TRC/TRV 50 P6T	3	3600	230	0,37	900
TRC/TRV 50 P8T	3	2600	140	0,18	700
TRC/TRV 50 P4/6T	3	5600/3600	540/230	0,75/0,25	1400/900
TRC/TRV 50 P6/8T	3	3600/2600	230/140	0,37/0,15	900/700
TRC/TRV 60 P4T	3	7800	620	1,5	1400
TRC/TRV 60 P6T	3	5100	260	0,37	900
TRC/TRV 60 P8T	3	3900	155	0,18	700
TRC/TRV 60 P4/6T	3	7800/5100	620/260	1,1/0,37	1400/900
TRC/TRV 60 P6/8T	3	5100/3900	260/155	0,37/0,15	900/700
TRC/TRV 70 P4T	3	9500	900	2,2	900
TRC/TRV 70 P6T	3	7000	380	0,75	900
TRC/TRV 70 P8T	3	5500	230	0,37	700
TRC/TRV 70 P4/6T	3	9500/7000	900/380	2,2/0,75	1400/900
TRC/TRV 70 P6/8T	3	7000/5500	380/230	1,25/0,60	900/700
TRC/TRV 80 P6T	3	10700	490	1,1	900
TRC/TRV 80 P8T	3	8400	290	0,55	700
TRC/TRV 80 P6/8T	3	10700/8400	490/290	1,25/0,60	900/700
TRC/TRV 90 P6T	3	14000	550	2,2	900
TRC/TRV 90 P8T	3	11000	330	1,1	700
TRC/TRV 90 P6/8T	3	14000/11000	550/330	1,84/0,81	900/700
TRC/TRV 100 P6T	3	18200	640	3	900
TRC/TRV 100 P8T	3	15000	15000	2,2	700
TRC/TRV 100 P6/8T	3	18200/15000	18200/15000	3/1,5	900/700
TRC/TRV 110 P6T	3	23800	720	4	900
TRC/TRV 110 P8T	3	19000	430	3	700
TRC/TRV 110 P6/8T	3	23800/19000	720/430	4,4/2,9	900/700
TRC/TRV 120 P6T	T	30000	760	7,5	900
TRC/TRV 120 P8T	T	24800	460	4	700
TRC/TRV 120 P6/8T	T	30000/24800	760/460	7,5/3,7	900/700



CURVE CARATTERISTICHE 4 POLI

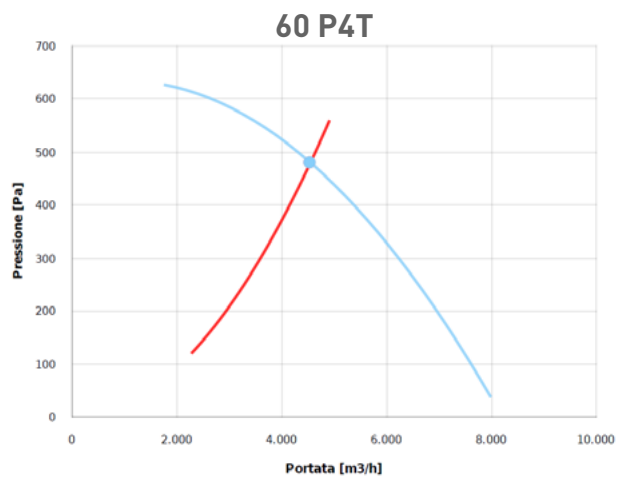
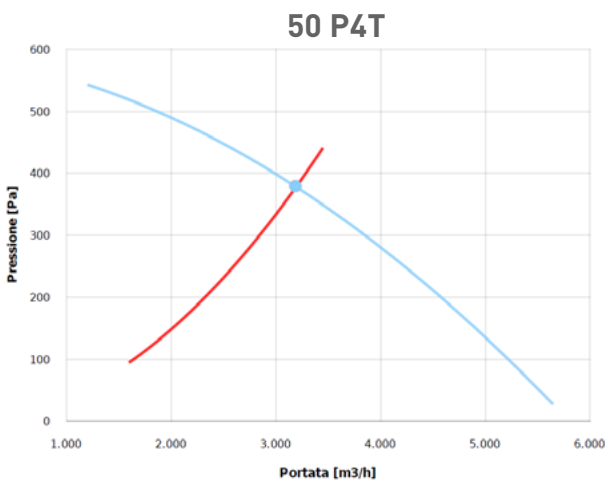
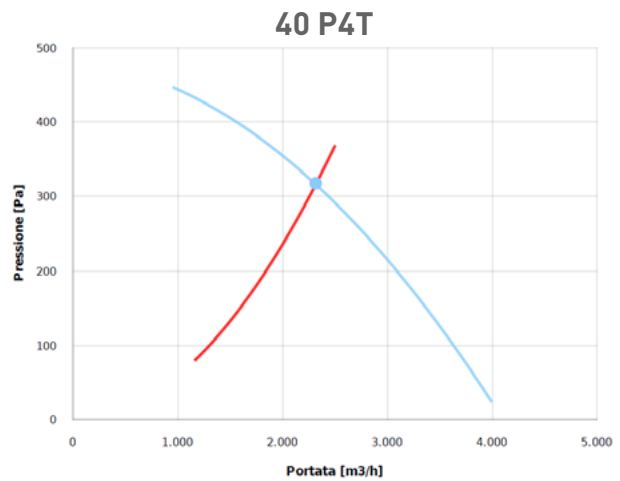
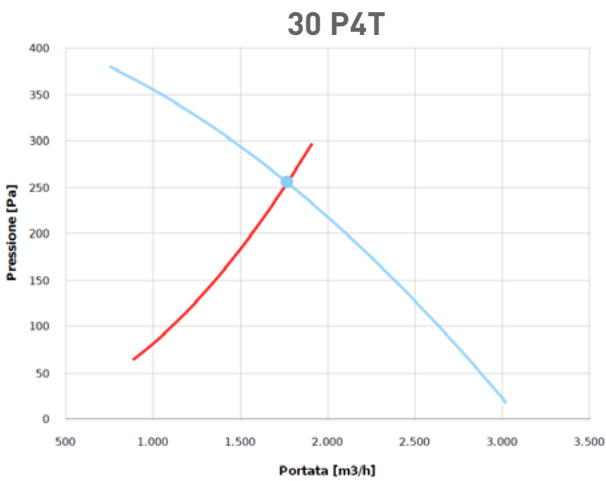
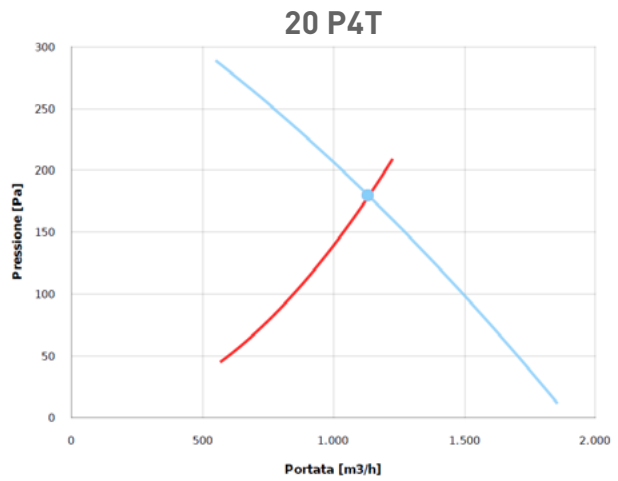
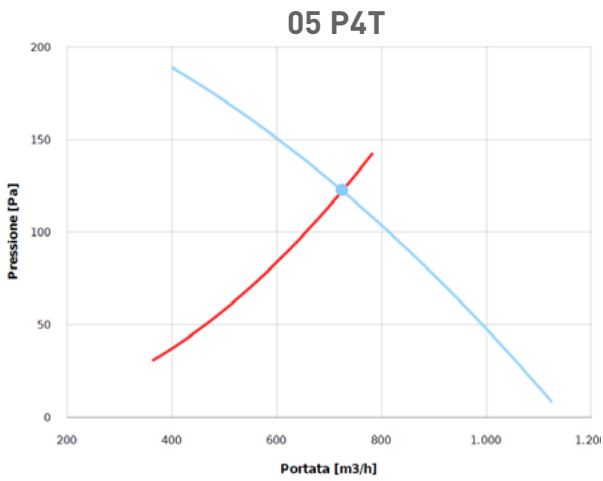

CURVE CARATTERISTICHE 6 POLI

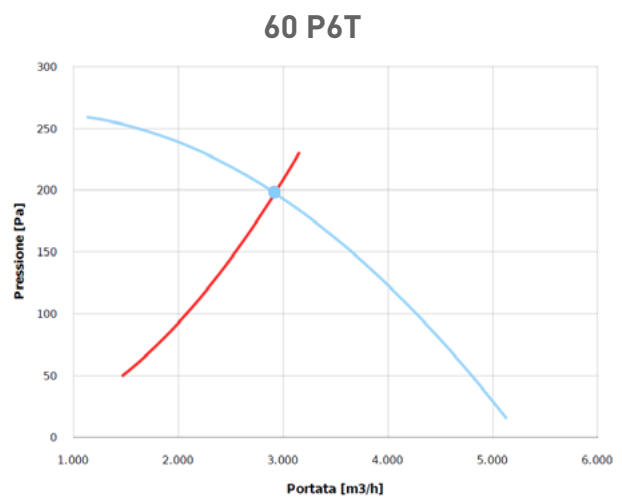
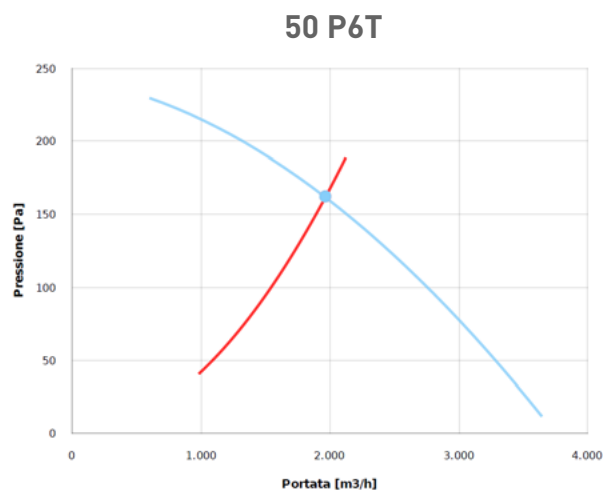
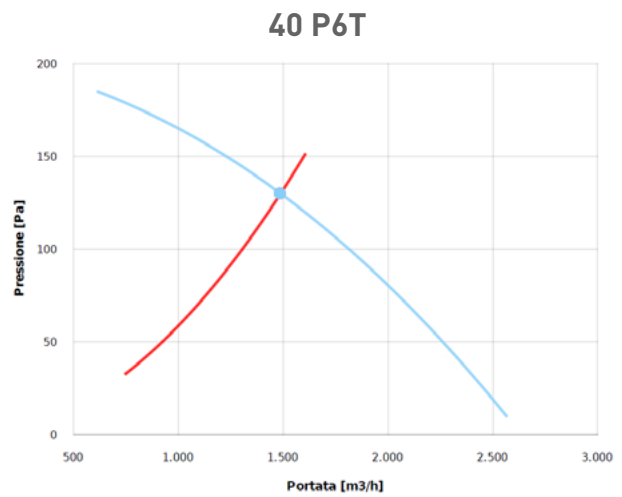
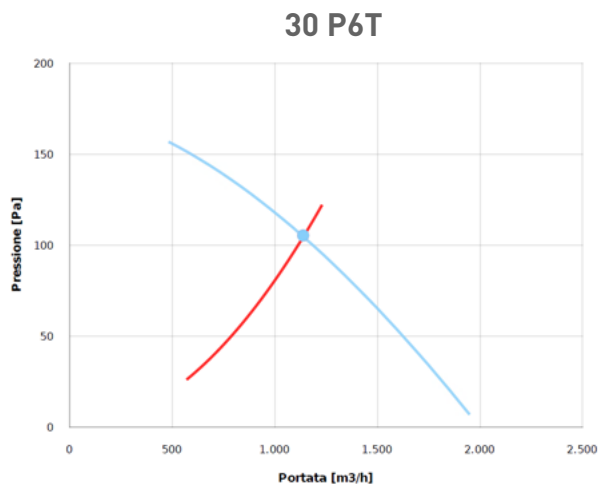
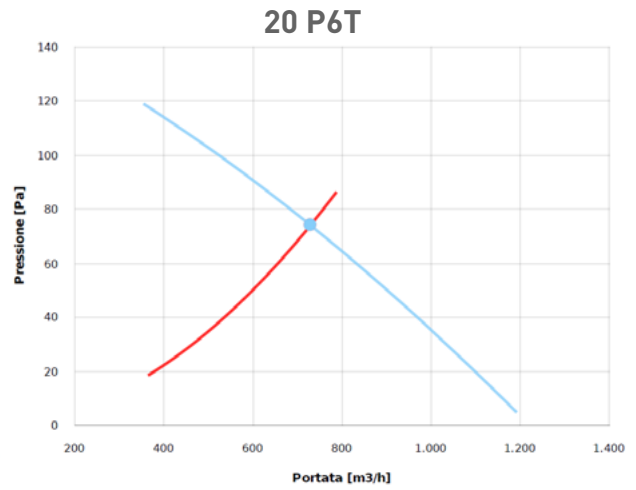
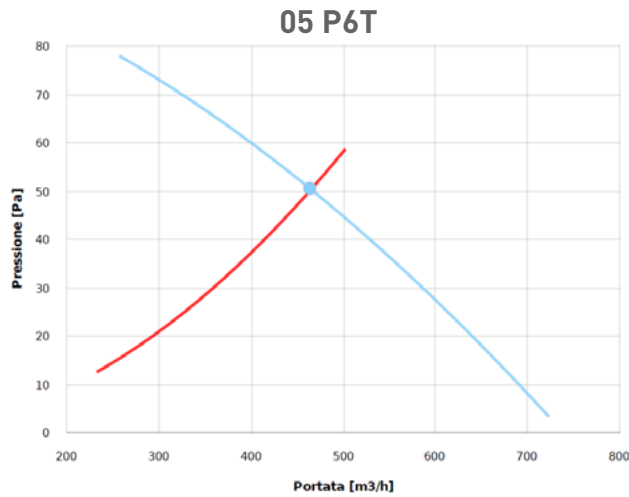



Ventilazione

Comfort e prestazioni
alla massima efficienza
energetica

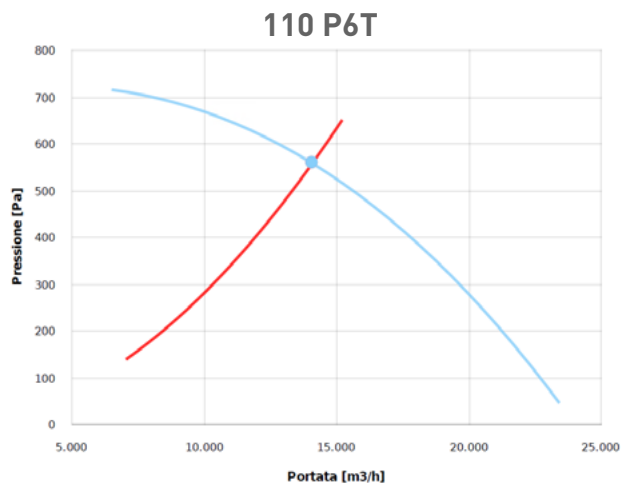
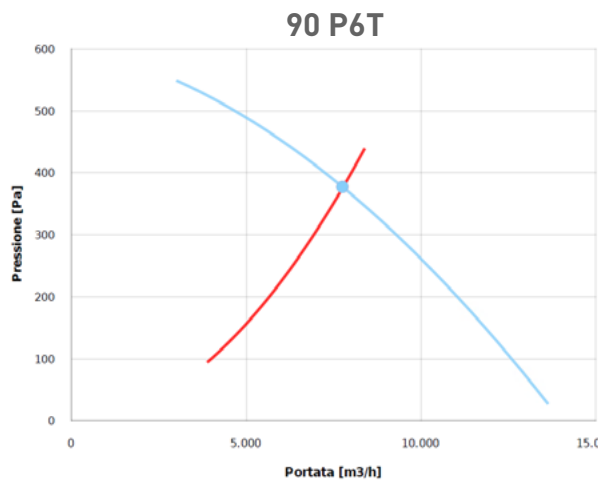
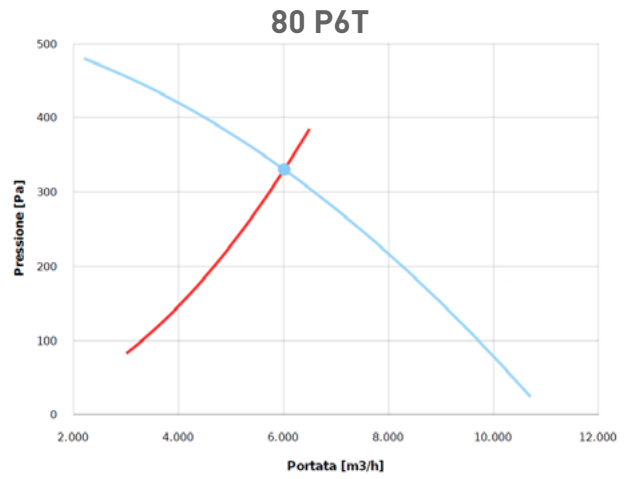
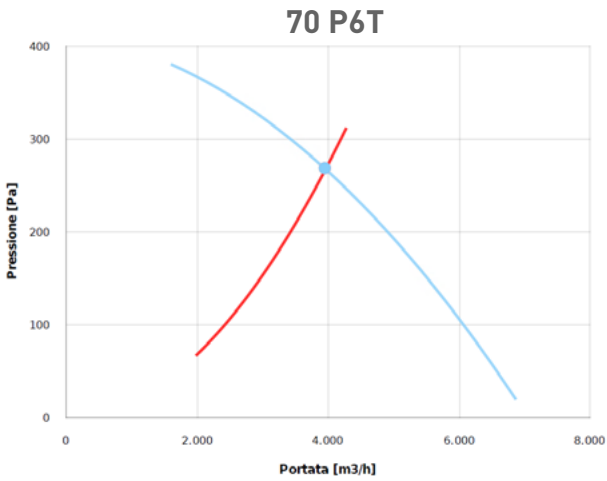

CURVE CARATTERISTICHE 8 POLI

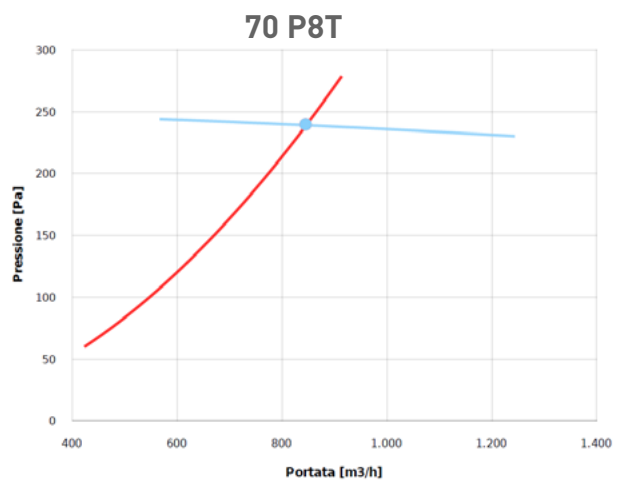
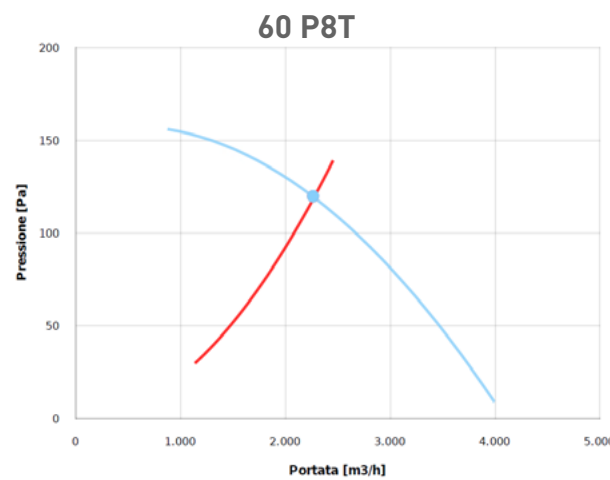
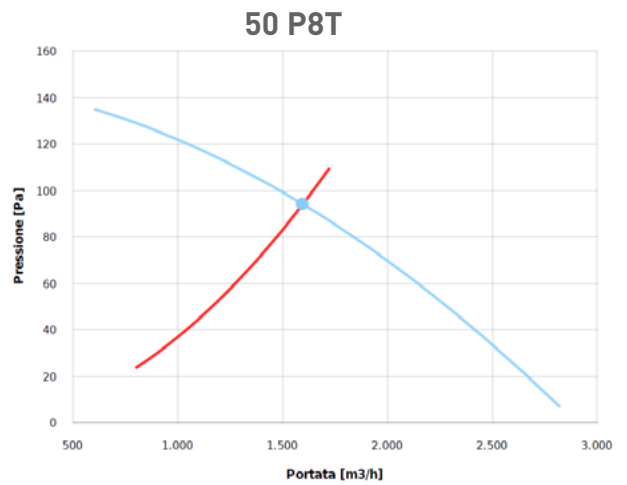
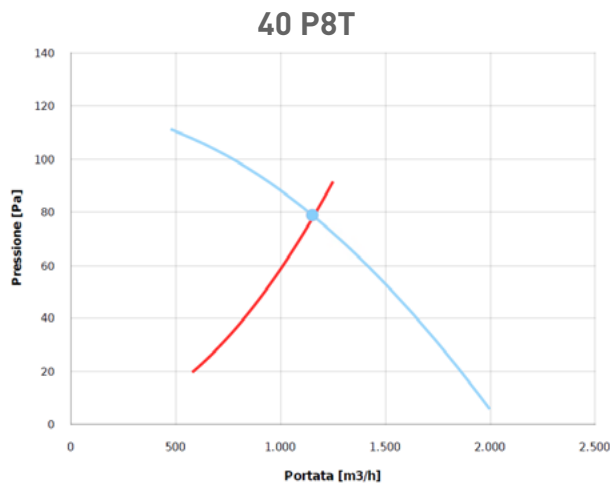
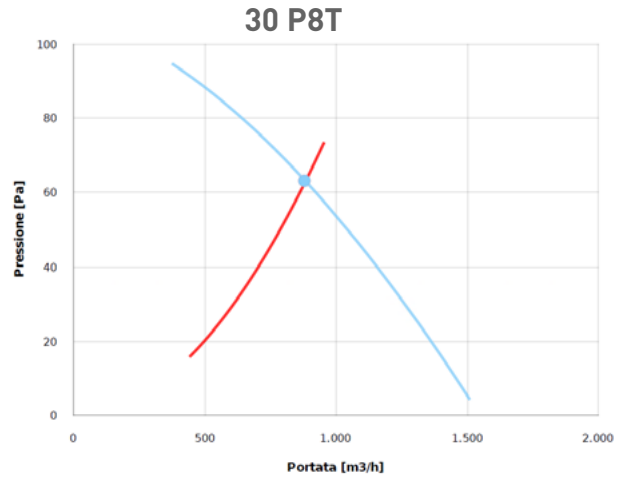
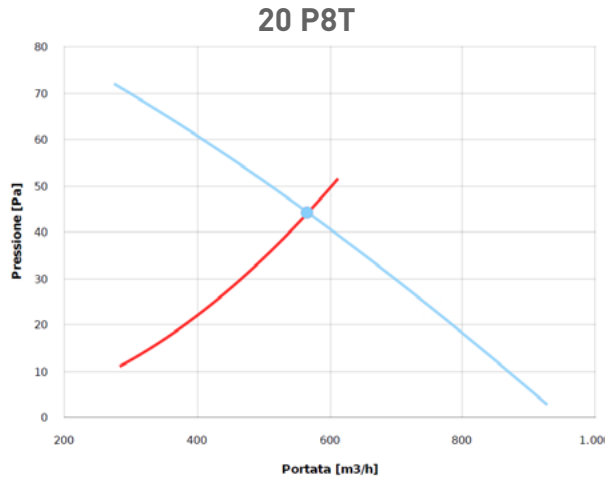



Ventilazione

Comfort e prestazioni
alla massima efficienza
energetica

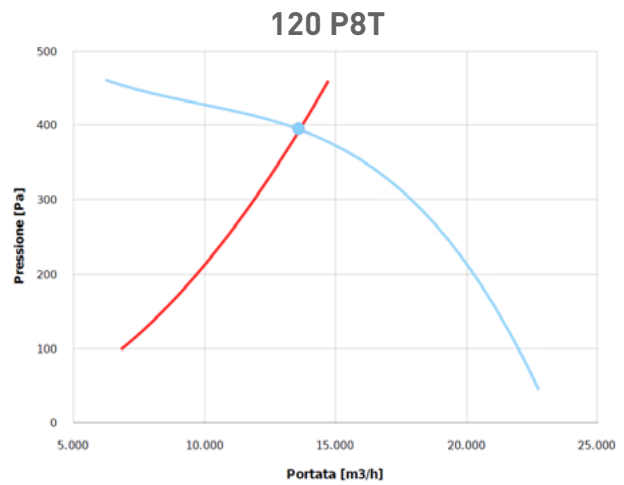
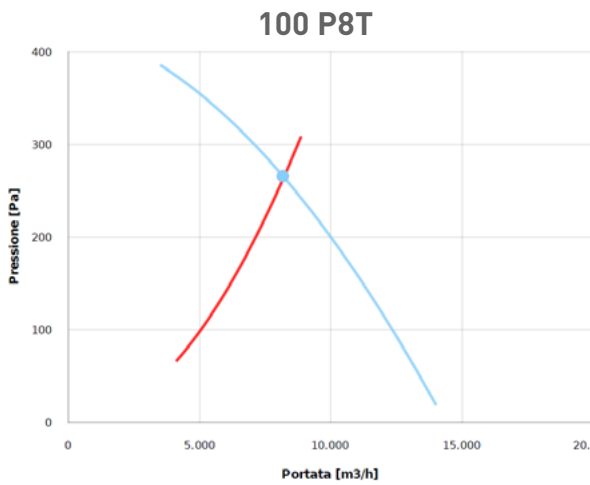
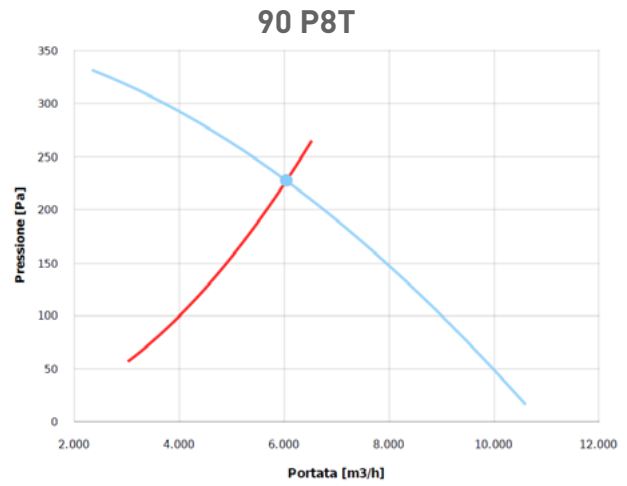
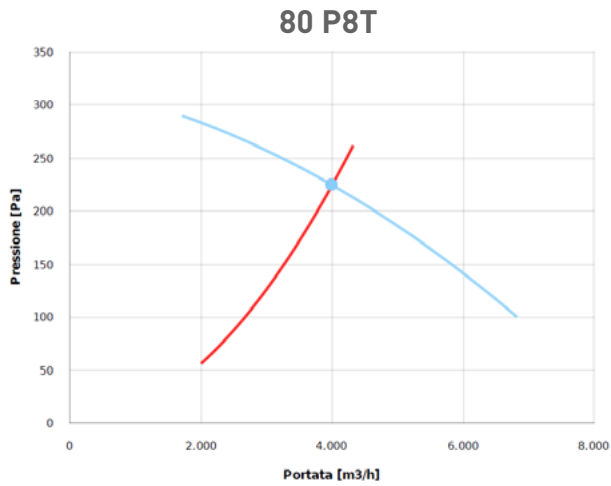

ACCESSORI



Serranda a gravità



Controbasse a murare



Regolatore velocità
monofase



RVIT
Inverter IP20 e IP66

Tutte le immagini sono soltanto indicative della tipologia di prodotto e possono differire dall'articolo.