

TRE

Torrino di estrazione assiale a getto orizzontale



Prodotto

TRE

Costruzione

Struttura in lamiera di acciaio zincato, cupola parapigioggia in polimero termoplastico (ABS), rete di protezione tra motore e girante

Applicazioni

Estrazione vapori e fumi, rinnovo aria in edifici commerciali e officine, magazzini

CARATTERISTICHE

Estrattore assiale da tetto a getto orizzontale, per estrazione aria viziata con temperatura di esercizio compresa tra i -20°C e i +50 °C. Trova impiego sia in capannoni industriali, magazzini ecc. ma anche in edifici commerciali e in generale in tutti quei casi dove si rende necessaria l'aspirazione di grandi portate d'aria (comprese tra i 1000 m³/h e i 44000 m³/h).

VENTILATORE

Girante elicoidale con pale a profilo alare in polipropilene rinforzato con fibra di vetro, mozzo in pressofusione di alluminio.

MOTORE

Grado di protezione IP 55 e isolamento classe "F", motori monofase con tensione alimentazione 230 V 50 Hz, motori trifase a una velocità con tensione 230/400 V 50 Hz, motori trifase a due velocità con unica tensione 400 V 50 Hz.

DIMENSIONALI

TRE

Taglia	Dimensioni (mm)						Peso kg
	A	B	C	øD	E	h	
400	650	550	750	410	40	500	36
450	700	600	750	468	40	520	44
500	750	650	750	515	40	540	55
560	850	750	1000	564	45	650	65
630	900	800	1000	640	45	700	80
710	1000	900	1000	715	45	700	90
800	1100	1000	1400	810	45	720	105
900	1250	1150	1400	912	45	740	135
1000	1400	1300	1400	1013	45	780	155





TABELLA DI SELEZIONE RAPIDA

Modello TRV/TRV	Dati tecnici				
	Fase	Portata aria max	Pressione st. max	Potenza	Velocità
		(m ³ /h)	(Pa)	(kW)	(RPM)
TRE 404 M	1	4400	130	0,18	1400
TRE 404 T	3	4400	130	0,18	1400
TRE 406 T	3	2850	50	0,18	900
TRE 404/6 T	3	4400/2850	130/50	0,26/0,09	1400/900
TRE 454 M	1	7050	120	0,37	1400
TRE 454 T	3	7050	120	0,37	1400
TRE 456 T	3	4650	65	0,18	900
TRE 454/6 T	3	7050/4650	120/65	0,37/0,12	1400/900
TRE 504 M	1	9200	145	0,55	1400
TRE 504 T	3	9200	145	0,55	1400
TRE 506 T	3	6000	65	0,18	900
TRE 504/6 T	3	9200/6000	145/65	0,55/0,18	1400/900
TRE 564 M	1	13300	225	1,1	1400
TRE 564 T	3	13300	225	1,1	1400
TRE 566 T	3	8150	85	0,37	900
TRE 56/8 T	3	6450	50	0,12	700
TRE 564/6 T	3	13300/8150	225/85	1,1/0,37	1400/900
TRE 566/8 T	3	8150/6450	85/50	0,37/0,15	900/700
TRE 634 T	3	17100	240	1,5	1400
TRE 636 T	3	10600	95	0,37	900
TRE 638 T	3	8000	55	0,18	700
TRE 634/6 T	3	15800/9820	240/95	1,7/0,6	1400/900
TRE 636/8 T	3	10600/8000	95/55	0,37/0,15	900/700
TRE 716 T	3	16700	105	0,75	900
TRE 718 T	3	12400	55	0,37	700
TRE 716/8 T	3	16700/12400	105/55	1,25/0,60	900/700
TRE 806 T	3	25400	130	1,5	900
TRE 808 T	3	18800	65	0,55	700
TRE 806/8 T	3	25400/18800	130/65	1,25/0,60	900/700
TRE 906 T	3	33800	145	2,2	900
TRE 908 T	3	25000	80	1,1	700
TRE 906/8 T	3	33800/25000	145/80	2,2/1,1	900/700
TRE 1006 T	3	43700	180	3	900
TRE 1008 T	3	33000	100	1,5	700
TRE 1006/8 T	3	43700/33000	180/100	3,5/1,5	900/700

CURVE CARATTERISTICHE 4 POLI

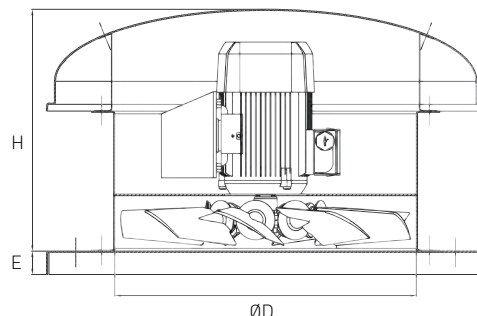
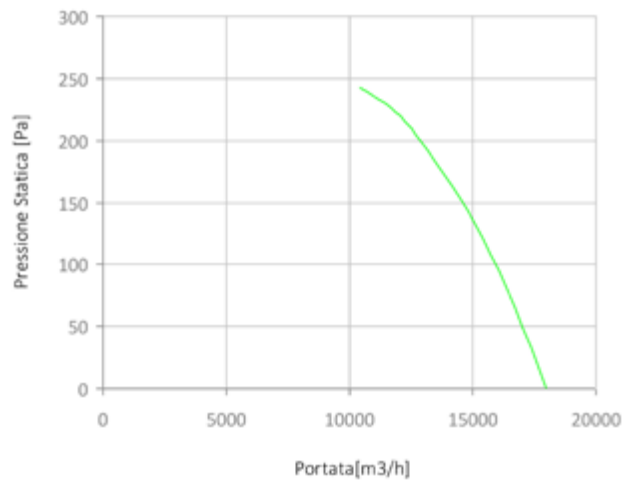
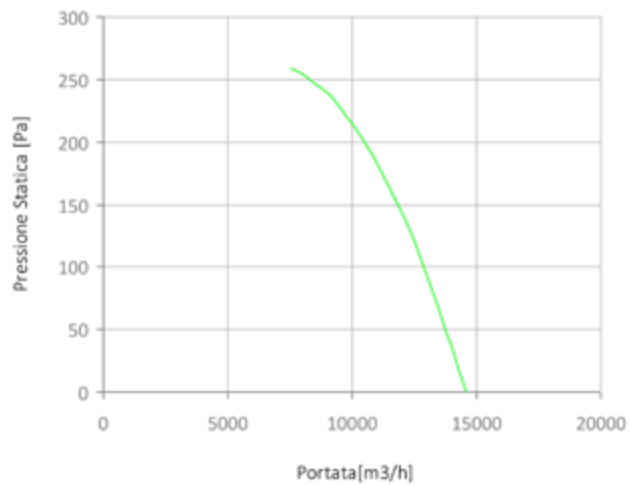
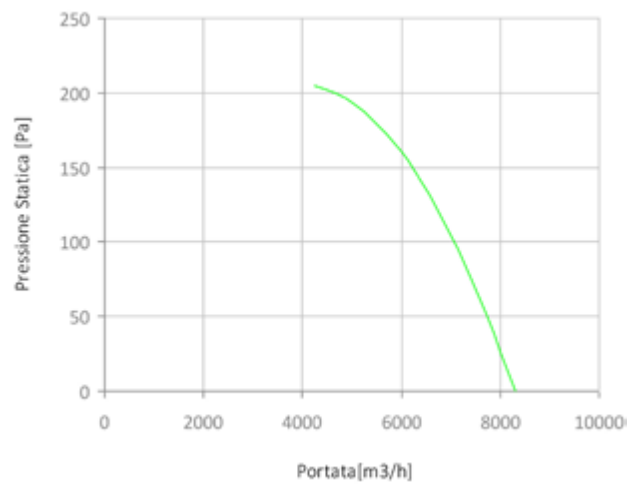
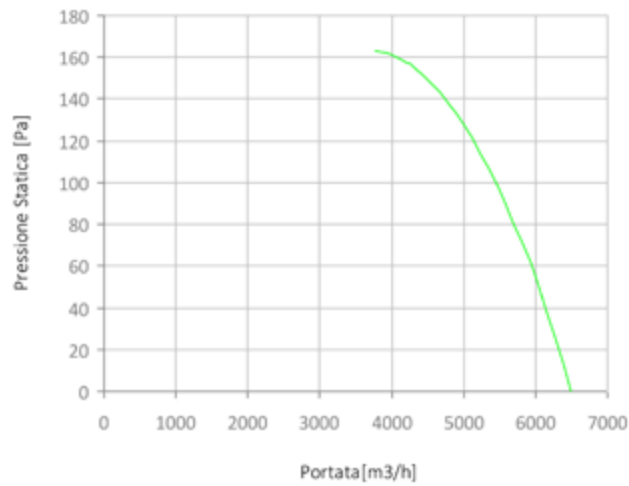
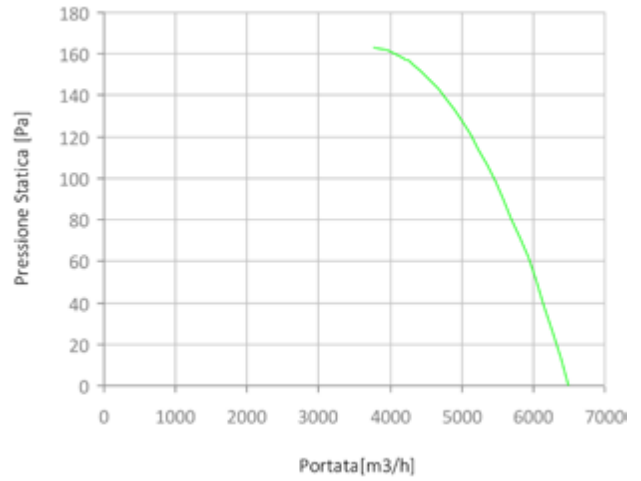
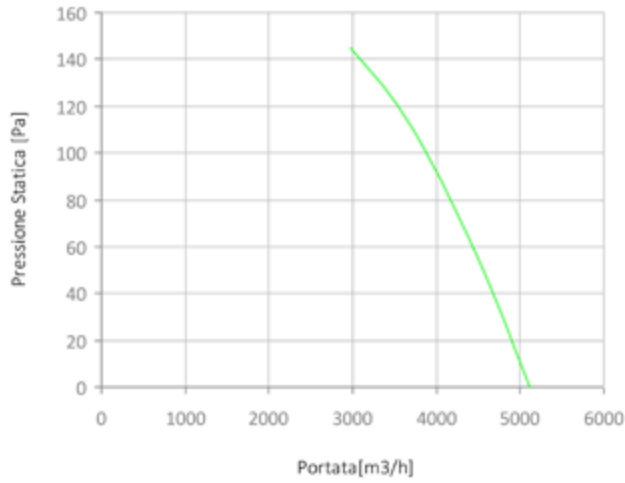



CURVE CARATTERISTICHE 6 POLI

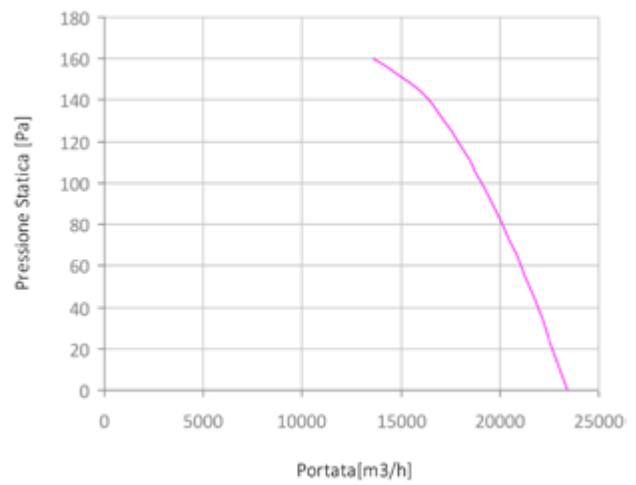
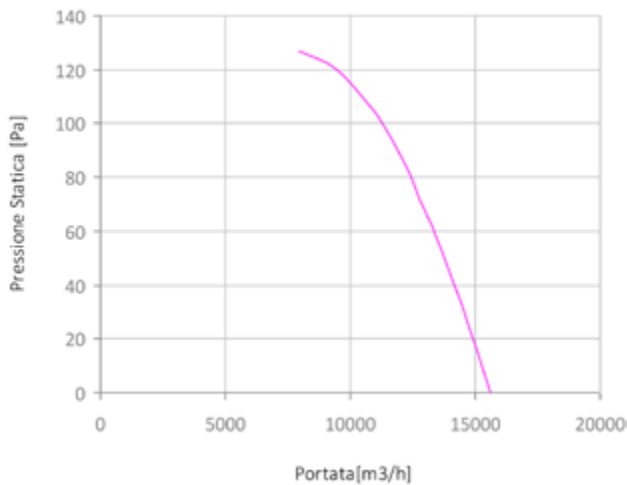
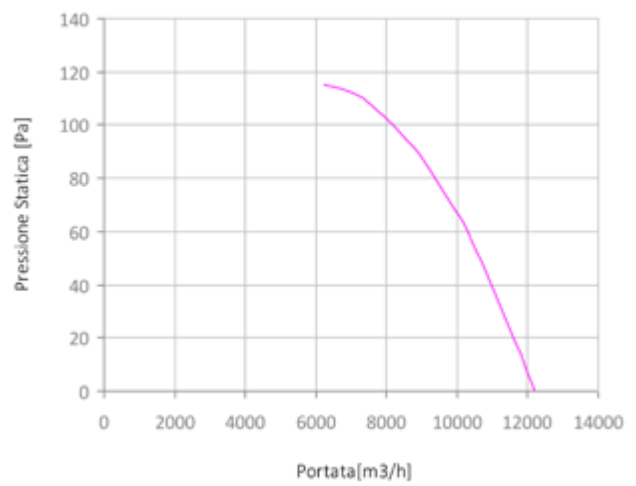
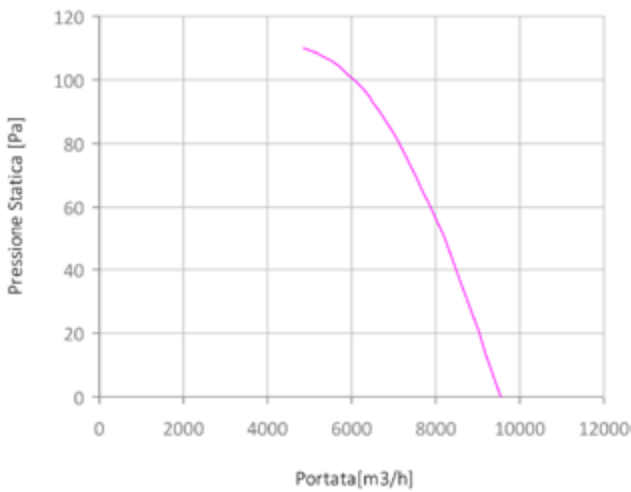
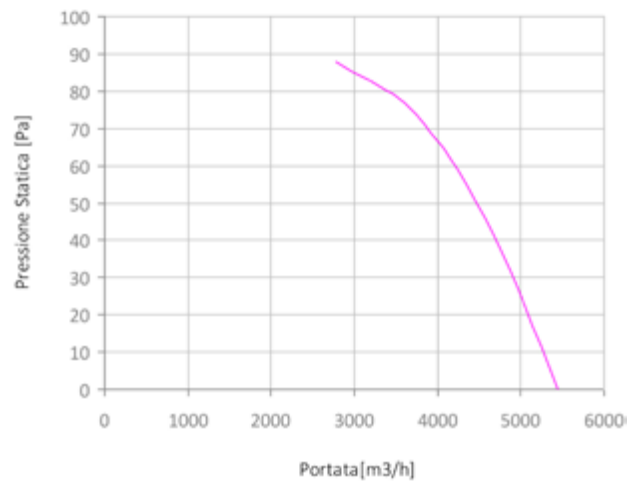
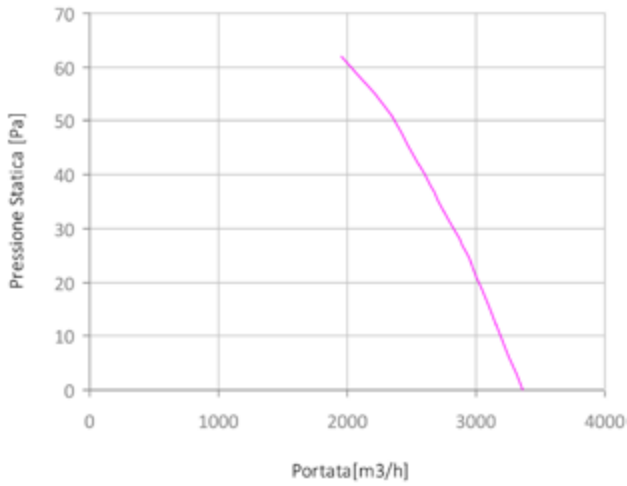

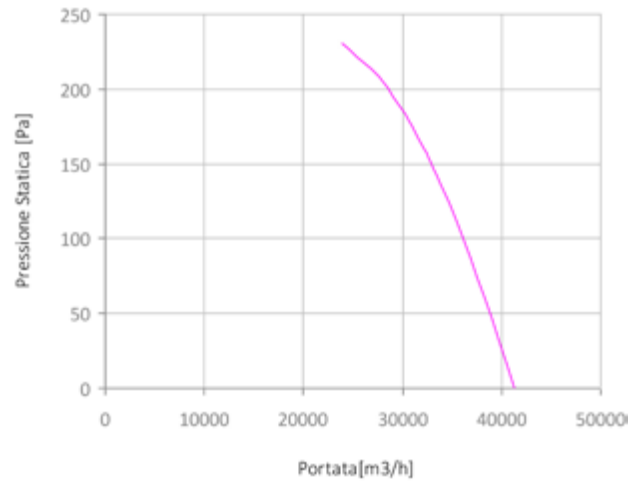
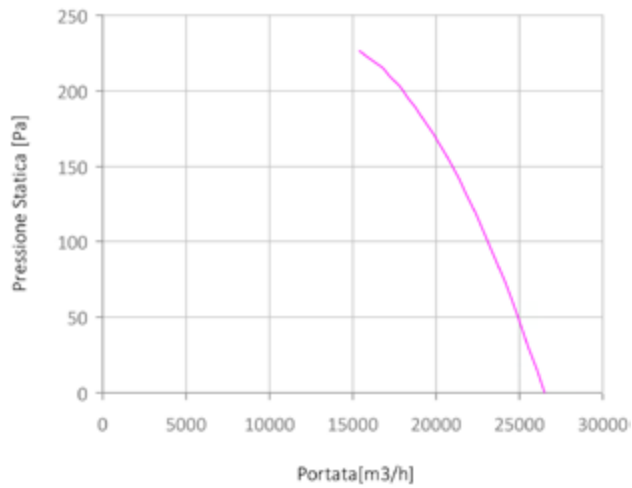



CURVE CARATTERISTICHE 8 POLI

